

29 153 LS0 GROHTHERM SMARTCONTROL THERMOSTAT FOR CONCEALED INSTALLATION WITH ONE VALVE

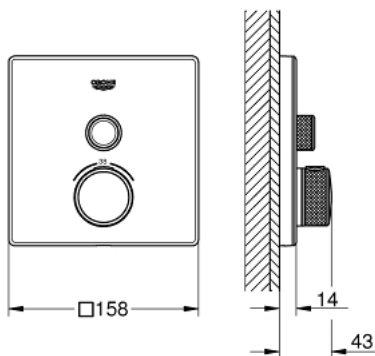

PRODUCT DESCRIPTION

- Colour: moon white/chrome
- trim set for GROHE Rapido SmartBox (35 600/35 604)
- Metal wall escutcheon with GROHE FastFixation (covered escutcheon and shaft sealing, covered fixing), 6° angle adjustable
- GROHE LongLife finish
- GROHE SmartControl - control the shower with intuitive push/turn button
- Includes various icons to customize push buttons
- GROHE TurboStat - compact cartridge with wax thermoelement
- GROHE ProGrip - with knurl structure
- GROHE SafeStop - safety button at 38°C
- GROHE SafeStop Plus - optional temperature limiter at 43°C or 46°C included
- Built-in check valve with dirt strainer
- Cover plate in moon white acrylic glass
- Requires Rough-In Set (29 038 001) (sold separately)
- flow performance: outlet A (to external shut-off) = 34 l/min outlet B/C = 29 l/min

29 153 LS0 GROHTHERM SMARTCONTROL THERMOSTAT FOR CONCEALED INSTALLATION WITH ONE VALVE

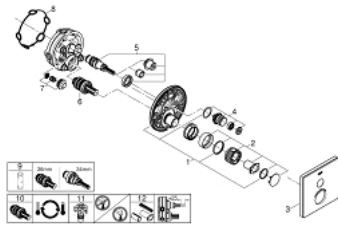

SPARE PARTS, June 2018 – now

- 1: Mounting plate (Spare part-nr. 48362000)
 - 2: Temperature control handle (Spare part-nr. 49029000)
 - 2.1: Cover cap (Spare part-nr. 1015030000)
 - 2.2: handle adaptor (Spare part-nr. 1015059990)
 - 3: Escutcheon (Spare part-nr. 49038LS0)
 - 4: Push button (Spare part-nr. 48361000)
 - 4.1: pushbutton (Spare part-nr. 14077000)
 - 5: Cartridge (Spare part-nr. 48359000)
 - 5.1: Spindle (Spare part-nr. 49088000)
 - 6: 3/4" Thermostatic compact cartridge (Spare part-nr. 49028000)
 - 7: Non-return valve (Spare part-nr. 49085000)
 - 8: Seal (Spare part-nr. 48360000)
 - 9: Socket Spanner (Spare part-nr. 49059000)*
 - 10: 3/4" Reversed TurboStat Cartridge (Spare part-nr. 49003000)*
 - 11: **Service Stops** (Spare part-nr. 1405300M)*
 - 12: Universal extension set single-lever mixers, 25 mm (Spare part-nr. 14048000)*
- * Optional accessories